

## Kinetics of Thin Layer Drying of Poultry Manure

A.E. Ghaly and K.N. MacDonald

Department of Process Engineering and Applied Science, Dalhousie University, Halifax, Canada

Received 2012-06-05; Revised 2012-06-14; Accepted 2012-06-18

### ABSTRACT

The poultry industry is one of the largest and fastest growing sectors of livestock production in the world. The estimated 2010 world flock was over 18 billion birds with a yearly manure output of 22 million tonnes. Storage and disposal of raw poultry manure has become an environmental problem because of the associated air, water and soil pollution. Environmental and health problems such as odor and pathogens that may arise during and after land application of raw manure can be eliminated by drying. Dried manure can be utilized as a soil conditioner to improve soil tilth and reduce the problems associated with soil compaction and as a feed for ruminants because of its high nitrogen content. The aim of this study was to investigate the kinetics of thin layer drying of poultry manure and evaluate the effects of drying with heated air on the chemical and biological properties of manure. The effects of temperature and depth of manure layer were evaluated. The profile of the moisture content of poultry manure followed an exponential decay curve. The moisture decay constant was affected by the drying temperature and the depth of the manure layer. At the three temperature levels studied, the time required to dry poultry manure in 1 cm-deep layer was the least, followed by 2 and 3 cm-deep layers, respectively. The diffusion coefficient increased with both temperature and depth of drying layer, but did not show a linear increase with either variable. The optimum depth for drying manure (at which the highest drying effectiveness occurred) was 3 cm. Drying manure at 40-60°C resulted in the loss of 44-55% of the total Kjeldahl nitrogen, with losses increasing with both the temperature and depth of manure. The pH of the manure decreased from the initial value of 8.4 before drying to about 6.6 after drying. The odor analysis indicated that dried poultry manure did not have an offensive odor. Drying achieved 65.3 and 69.3% reductions in odor intensity and offensiveness, respectively. Reductions in the number of bacteria, mold/yeast and *E.coli* were 65-99, 74-99 and 99.97% respectively. The greatest reductions in microbial population occurred at the highest temperatures (60°C) and the thinnest manure depths (1 cm). Heated air drying of poultry manure at temperatures between 40 and 60°C was effective in killing pathogens and removing odor.

**Keywords:** pH, Depth, Diffusion, Drying Kinetics, Plant Nutrients, Time Moisture Content, Temperature, Effectiveness, Poultry Manure

### 1. INTRODUCTION

The poultry industry is one of the largest and fastest growing sectors of livestock production in the world with a 35% increase in meat and egg production during the period of 2000-2008 (FAO, 2010). The estimated 2010 world flock was over 18 billion birds with a yearly manure output of 22 million tonnes (FAO, 2010). With the rapid expansion of the industry over the last several decades, storage and disposal of raw poultry manure has become an environmental problem because of the associated air, water and soil pollution (Benali and Kudra, 2002). Poultry manure begins to decompose immediately after excretion giving off ammonia which,

in high concentrations, can have adverse effects on the health and productivity of birds as well as the health of the farm workers (Pierson *et al.*, 2001; Zhang and Lau, 2007; Amon *et al.*, 2006). Manure serves as a breeding ground for pathogenic microorganisms as well as a medium for diseases transmission among the birds. Flies and other undesirable insects can breed on the manure leading to the health hazards and nuisance associated with them (Lay *et al.*, 2011; Axtell, 1999). Manure is also a source of odor caused by the activity of anaerobic microorganisms in the manure (Miller and Berry, 2005; Fares *et al.*, 2005). It is, therefore, necessary to subject poultry manure to some treatments in order to improve its storage and handling and to

minimize the risk of disease transmission and environmental pollution.

Environmental problems such as odor and pathogens that may arise during and after land application of raw manure can be eliminated through drying of the manure. Dried manure can be utilized as a soil conditioner to improve soil tilth and reduce the problems associated with soil compaction (Kelleher *et al.*, 2002; Zhang and Lau, 2007; Tanabe *et al.*, 1985; Tam and Tiquia, 1999). Poultry manure has also been the focus of feeding to ruminants because of its high nitrogen content (Alam *et al.*, 2008). DeBoer (1981) reported that the results of a series of digestibility experiments on dried poultry manure feeding to ruminants showed an average net energy content of about 6400 kJ/kg dried manure and an average protein content of about 300 g/kg dried manure. The results of feeding experiments with young fattening bulls showed no effect on carcass-quality, or taste and smell of meat. Thomas *et al.* (1972) reported that feeding caged layer waste to dairy cattle did not affect the composition or flavour of milk.

Drying refers to the removal of moisture from the manure in order to minimize the rate of deterioration from chemical and biological activity and prevent the environmental problems associated with raw manure. Drying with heated air results in higher rates of oxidation and pathogen destruction (Loehr, 1977). Air can be heated using solar energy, electricity, natural gas or oil. However, solar energy offers many advantages over other energy sources. These include: (a) it is available in abundance all year round specifically in the tropics, (b) it is relatively cheap to collect and utilize, (c) it has a higher rate of oxidation and (d) it results in good waste stabilization, odor control and pathogen destruction (Amine-Khodja *et al.*, 2006). El-Sayed (1993) estimated the output air temperature from a solar collector to be in the range of 25-66°C.

The main aim of this study was to investigate the thin layer drying of poultry manure and evaluate the effects of drying with heated air on the chemical and biological properties of manure. The specific objectives were to: (a) evaluate the drying behaviour of laying hen manure at temperatures in the range of 40-60°C and depths of 1-3 cm, (b) determine the kinetic parameters of thin layer drying and (c) determine the changes in the chemical and biological properties of the manure as a result of the drying process.

## 2. MATERIALS AND METHODS

### 2.1. Drying Trays

Three sets of trays (each set consisting of three trays of the same dimensions) were constructed from

galvanized metal sheets and used for the drying of poultry manure. Each tray had a drying surface area of 100 cm<sup>2</sup>. The depths of the trays were 1 cm, 2 cm and 3 cm for sets 1, 2 and 3, respectively. **Figure 1** shows the dimensions of a drying tray.

### 2.2. Manure

Poultry manure was obtained from a layers house located in Stewiack East, approximately 80 km from Halifax, Nova Scotia. The manure was collected under the battery cages of a laying house accommodating approximately 50,000 hens. The raw manure was not subjected to any treatment on the farm. It was placed in clean plastic bags and transported to the Waste Management Laboratory at Dalhousie University in Halifax, Nova Scotia where it was stored at -18°C. Some characteristics of the poultry manure used in this study are presented in **Table 1**.

### 2.3. Experimental Procedure

The effects of three drying temperatures (40, 50 and 60°C) and three manure depths (1-3 cm) on the manure drying time, rate and effectiveness and manure characteristics were investigated. Prior to placing the manure in the drying trays, it was removed from the freezer and allowed to thaw for 24 h at room temperature (22°C). The three sets of trays were weighed using a digital balance (METTLER Balance model PM4600, Fisher Scientific, Montreal, Quebec). The trays were then filled to their respective depths with the manure and weighed again. The trays and manure were then placed in a forced draft oven (Isotemp Oven Model 655F, Fisher Scientific and Montreal, Quebec) which was adjusted to the required temperature. The drying rate was monitored by determining the change in weight at 2 h time intervals until there was no change in weight. The oven temperature was then readjusted to the next level and the same experimental procedure was followed. Three replicas were carried out for each temperature-manure depth combination.

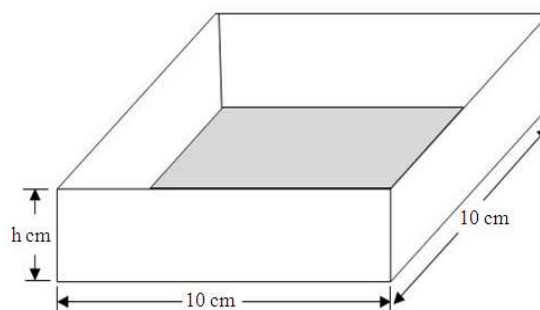

**Fig. 1.** Dimensions of drying trays (h= 1,2 or 3 cm)

**Table 1.** Some characteristics of the poultry manure used in the study

Item	Measured value
Moisture content	78.4 %
Density	960 kg/m <sup>3</sup>
Total solids	215520 mg/L
Volatile solids	139770 mg/L
Ash	75750 mg/L
Total Chemical Oxygen Demand	328500 mg/L
Soluble Chemical Oxygen Demand	130000 mg/L
Total Kjeldahl Nitrogen	18960 mg/L
Ammonium Nitrogen	9470 mg/L
Calcium	19760 mg/L
Phosphorous	5590 mg/L
Potassium	4140 mg/L
pH	8.40

## 2.4. Experimental Analyses

The manure properties were determined before drying. These were: moisture content, density, total solids and volatile solids, ash, total and soluble chemical oxygen demand, total-Kjeldahl nitrogen, ammonium-nitrogen, Ca, P and K contents, pH, total microbial counts, pathogens, insect and odor analysis. The moisture content, density, pH, total and volatile solids, total and soluble COD, Ca, P, K, total- Kjeldahl nitrogen, ammonium- nitrogen, total microbial count, pathogens, insects and odor analyses, were performed on the dried samples. The pH, density, solids, chemical oxygen demand analyses were performed in the biotechnology laboratory of Dalhousie University, Halifax, Nova Scotia according to the procedures described in the Standard Methods for examination of water and waste water (APHA, 1981). The moisture content, Ca, P, K, total Kjeldahl nitrogen and ammonium nitrogen analyses, microbial and insect analyses and odor tests were performed as follows.

### 2.4.1. Moisture Content

The moisture content was determined using the oven drying method according to the procedure described in the ASABE Standards (ASABE, 2008). Samples of approximately 10 g were dried at 103°C for 24 h in a drying oven (Isotemp Oven Model 655F, Fisher Scientific, Montreal, Quebec) and the Moisture Content (MC) was calculated as follows Equation 1:

$$MC (\%wb) = \frac{(\text{Weight of wet samples} - \text{Weight of dry sample}) \times 100}{\text{Weight of wet samples}} \quad (1)$$

### 2.4.2. Elemental Analysis

The Ca, P and K analyses were performed in the Mineral Engineering Centre of Dalhousie University, Halifax, Nova Scotia. The phosphorous content was determined by the colorimetric method using a molybdivandate solution after leaching the samples with

perchloric acid (HClO<sub>4</sub>), hydrofluoric acid (HF) and nitric acid (HNO<sub>3</sub>). The Potassium and calcium contents were determined by atomic absorption after leaching samples with HNO<sub>3</sub> and hydrochloric acid (HCl). These analyses were carried out according to the procedures described in the Official Methods of Analysis of the Association of Official Analytical Chemists (AOAC, 2006). Both the Total Kjeldahl Nitrogen (TKN) and ammonium nitrogen (NH<sub>4</sub>-N) contents were determined using a Kjelteltech Auto Analyzer (Model 1030, Part No. 1000 1773, Serial No. 2000, Tecator AB, Hoganas, Sweden). A one gram sample of the manure was diluted with 20 ml of distilled water for NH<sub>4</sub>-N analysis. For the TKN analysis, one gram of the manure was digested with 4 mL of concentrated sulfuric acid (H<sub>2</sub>SO<sub>4</sub>) for 25 min under a vacuumed ventilator. The analyte was then automatically titrated by the analyzer.

### 2.4.3. Total Microbial Count

The number of viable aerobic and facultative microorganisms was established based on the assumption that each viable cell would develop into a colony during incubation. Manure samples were collected in wide mouth sterilized containers. Each sample was diluted to insure that one of the final plates would have 30 - 300 colonies (the number of colonies within this range gives the most accurate approximation of the microbial population). The initial dilution (1:10) was prepared by placing 1 g of manure into 10 mL of physiological saline water. The bottle was then shaken vigorously to obtain a uniform distribution of organisms. Further dilutions (1:10<sup>3</sup>, 1:10<sup>4</sup>, 1:10<sup>5</sup>, 1:10<sup>7</sup>, 1:10<sup>8</sup>) were made by pipetting measured aliquots into additional dilution waters. Sterile petri dishes were first labeled (specimen and dilution), then each bottle was thoroughly shaken and 1 mL of the appropriate dilution was pipetted into each petri dish. Approximately 15 mL of cooled melted medium was poured into each petri dish. Immediately thereafter, the plates were gently rotated 6 times in each direction to distribute the inoculum throughout the medium. The plates were allowed to solidify and were incubated in the inverted position in an incubator (Model Number 2020, VWR International, Cornelius, Oregon) at 35-37°C for 48 h. Three replicates from each dilution were carried out. Plates that contained a number of colonies in the range of 30-300 were selected. An accurate count of the colonies was made by placing the plate on the platform of a colony counter (Cat.No.7-910, Fisher Scientific, Montreal, Quebec). This instrument facilitated the counting process since the colonies were illuminated and seen against a ruled background. The number of colonies counted on each plate was multiplied by the dilution of the specimen which the plate represents. This gave the number of colonies per milliliter.

Name: \_\_\_\_\_  
 Date: \_\_\_\_\_

A. Rate the samples to the presence of odor and the odor as to offensiveness according to the following scale using samples "0" as having 0 rating and samples "10" as having 10 rating.

Presence		Offensiveness	
No odor	0	No offensive odor	0
Very faint	1-2	Very faint offensive odor	1-2
Faint	3-4	Faint offensive odor	3-4
Definite	5-7	Definite offensive odor	5-7
Strong	8-9	Strong offensive odor	8-9
Very strong	10	Very strong offensive odor	10

B. Describe the odor of each sample by giving an appropriate descriptive term. Possible terms that might be used are given in the list below or you may use a term of your choice which you feel properly describes the odor.

Mold, musty	Yeast
Fish	Ammonia
Stagnant water	Grain, animal feed
Sulfide, rotten eggs	Sour, fermented
Petroleum	Rotten cabbage, mercaptans
Earth	Other (Please specify)

**RATING**

Sample	Presence Rating	Offensiveness Rating	Odor Description
1			
2			
3			

Thank you for your time

Fig. 2. Odor evaluation sheet

#### 2.4.4. Microbial and Insect Analyses

The following analyses were also performed on raw dried manure samples: (a) yeast and mold enumeration, (b) *E. Coli* estimation, (c) *Salmonellae* examination and (d) microscopic examination of insect, flies eggs and parasite. These analyses were performed at Phillips Analyticals, Dartmouth, Nova Scotia.

#### 2.4.5. Odor

A specially developed organoleptic test for the measurement of odor from animal waste was used to measure the presence and offensiveness of odor in poultry manure. This method was chosen because of the complex nature of manure odor which is best judged by the human nose. Scales of 0-10 were utilized to rate the odor as to its presence and offensiveness. No odor was 0 and very strong odor was 10. Similarly, no offensive odor was 0 and very offensive odor was 10. The intermediate numbers 1-9 are described in the score sheet (Fig. 2), which was used by the panel members to rate the samples (50 g) placed before them in 125 black erlenmeyer flasks. Panel members were asked to rate the contents of the flasks according to the scales of 0-10 and to describe the odor on a separate data sheet. The lower limit (0) was

assigned to distilled water, whereas the upper limit (10) was assigned to fresh poultry manure. The odor testing panel (30 members) consisted of technicians, graduate and undergraduate students and faculty.

### 3. RESULTS AND DISCUSSION

#### 3.1. Moisture Content Profile

The profiles of the moisture contents of poultry manure as affected by the drying temperature and manure depth are shown in Fig. 3. The moisture contents followed an exponential decay curve which can be described by the following Equation 2:

$$MC_t = MC_i e^{-kt} \quad (2)$$

where:

$MC_t$  = Moisture content at time t (% wb)

$MC_i$  = Initial moisture content (% wb)

T = Time (h)

k = Moisture decay rate (h<sup>-1</sup>)

Equations 3 to 11 describe changes in moisture content at various temperatures and manure depths and are presented in Table 2. Since the initial moisture

content of all manure samples were the same (78.45% wet basis), variations in drying process as a result of temperature and manure depth can be determined by the moisture decay constants (K) as shown in Fig. 4. The results indicated that the manure depth and temperature affected the diffusion and evaporation processes, the higher the temperature and the thinner the manure layer, the greater the moisture decay rate.

Drying curves exhibiting an exponential decay in moisture content were also reported for drying of potato, carrot, pepper, garlic, mushroom, onion, leek, pea, corn,

celery and pumpkin (Krokida *et al.*, 2003), tomato (Hawllader *et al.*, 1991; Brooks *et al.*, 2008) and hemispherical solids (Bon *et al.*, 1997). Panchariya *et al.* (2002) observed that the thin layer drying kinetics for black tea was best represented by an exponential decay. Srinivasa (2007) found the exponential decay model to be the best fit to the thin layer drying of parboiled paddy. Several authors also showed accelerated drying processes with increased temperature during the drying process (Krokida *et al.*, 2003; Bon *et al.*, 1997; Okos *et al.*, 1992).

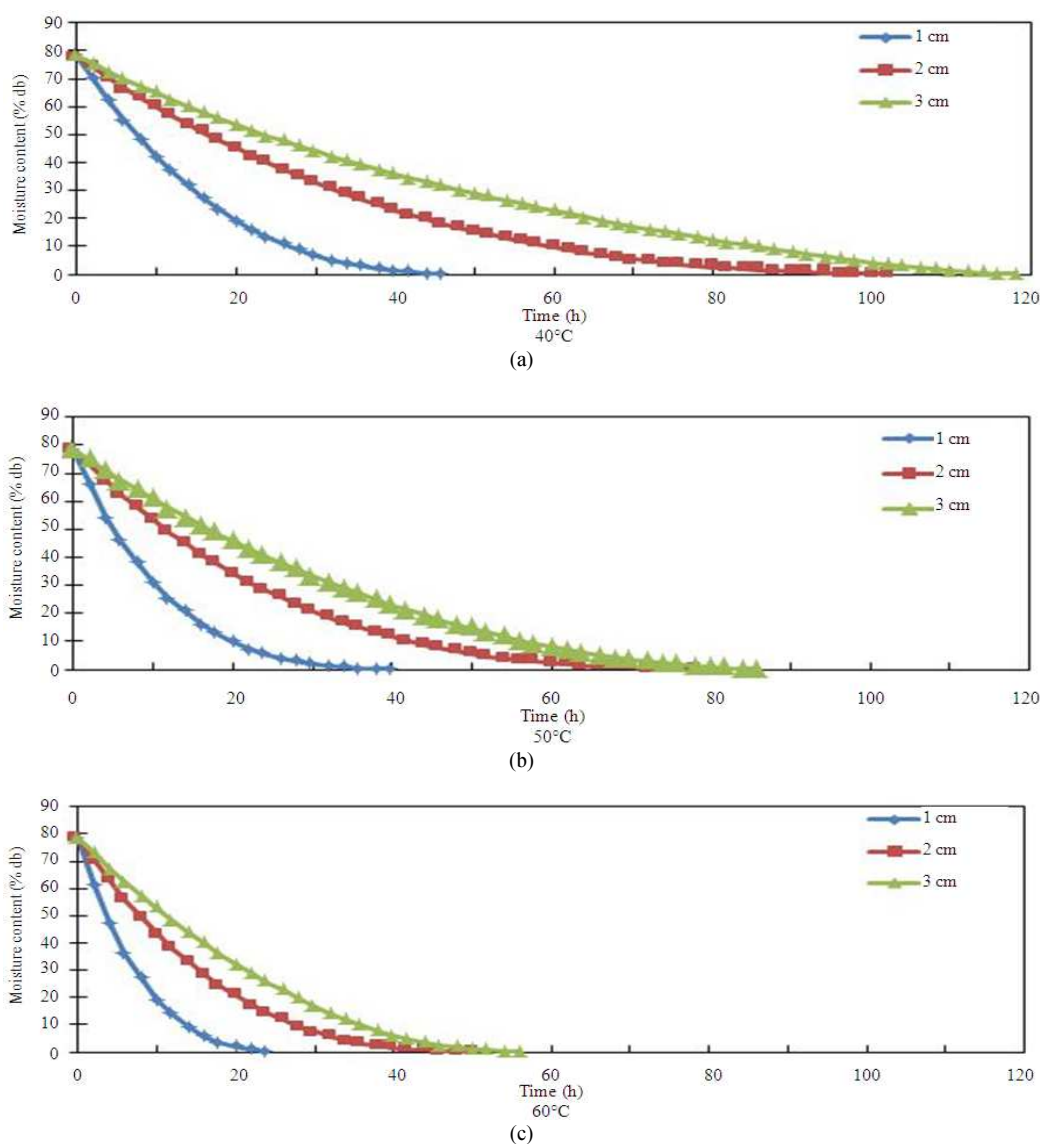
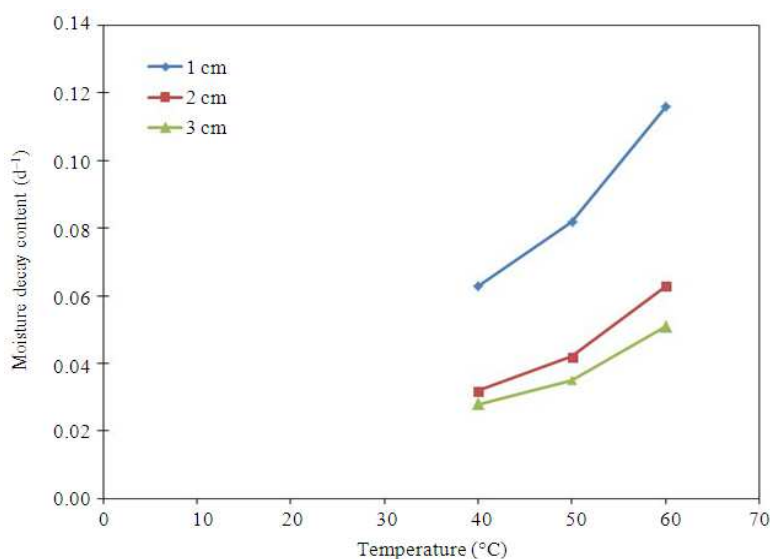

Fig. 3. Effect of drying temperature and manure depth on moisture content

**Table 2.** Equations describing the moisture content at various depths and temperatures

Drying Temperature (°C)	Drying Depth (cm)	Equation	R <sup>2</sup>	Equation Number
40	1	MC=78.45 e <sup>-0.060t</sup>	0.84	3
	2	MC=78.45 e <sup>-0.090t</sup>	0.73	4
	3	MC=78.45 e <sup>-0.189t</sup>	0.83	5
50	1	MC=78.45 e <sup>-0.258t</sup>	0.86	6
	2	MC=78.45 e <sup>-0.124t</sup>	0.86	7
	3	MC=78.45 e <sup>-0.091t</sup>	0.79	8
60	1	MC=78.45 e <sup>-0.351t</sup>	0.84	9
	2	MC=78.45 e <sup>-0.192t</sup>	0.85	10
	3	MC=78.45 e <sup>-0.144t</sup>	0.80	11



**Fig. 4.** Effect of temperature and manure depth on the moisture decay constant

**Table 3.** Drying time and drying effectiveness of poultry manure

Drying Temperature (°C)	Drying Depth (cm)	Drying Time (h)	Manure Weight (g)		Removed Moisture (g)	Drying Effectiveness (h/g)
			Initial	Final		
40	1	55	125.95	27.15	98.80	0.56
	2	106	224.70	48.43	176.27	0.60
	3	120	312.72	67.41	245.31	0.50
50	1	44	129.16	27.84	101.32	0.43
	2	84	226.21	48.71	177.50	0.47
	3	90	314.28	67.74	246.54	0.37
60	1	28	127.18	27.41	99.77	0.28
	2	52	227.86	49.11	178.75	0.29
	3	60	322.57	69.52	253.05	0.24

### 3.2. Drying Time and Effectiveness

The data on the drying time, removed moisture and drying effectiveness at various manure depths and drying temperatures is presented in **Table 3**. The parameter "drying effectiveness" is defined in this study as the time needed to drive off 1 g of moisture from the manure.

The results indicated that the 1 cm deep manure layer dried the fastest at all three drying temperatures, followed

by the 2 cm deep manure layer and the 3 cm deep manure layer. The thinner the manure layer, the lower the amount of moisture it contained and consequently the shorter the time duration required to drive off the moisture. The time required to dry the 2 cm deep manure layer was more than the time required to dry the 1 cm deep manure layer by about 106, 100 and 87% for the 40, 50 and 60°C temperatures respectively. The time required to dry the 3 cm deep manure layer was more than the time required to

dry the 2 cm deep manure layer by 22, 12 and 7% for the 40, 50 and 60°C temperatures respectively. This shows that the difference in drying time between the shallower and deeper manure layers decrease as the temperature increases. However, the drying effectiveness of the 3 cm manure depth was superior at all levels of temperature as less time was required to remove one gram of water from the manure. The results also showed that more time was required to remove one gram of water from manure at the 2 cm depth than those required at the 1 and 3 cm depths at all temperatures studied, as shown in **Fig. 5**.

Several researchers investigated the effect of depth on the drying time and effectiveness of various materials. Rao *et al.* (2007) investigated the effectiveness of thin layer drying of parboiled paddy at depths between 5 and 20 cm and observed the fastest drying time at a depth of 5 cm and the optimum effectiveness at a depth in the range of 7-10 cm. Nazghelichi *et al.* (2010) investigated the effect of bed depth (30, 60 and 90 mm) on the drying of carrot cubes and found the optimum drying time and efficiency to be achieved at the 30 mm depth. Maskan *et al.* (2002) investigated the effects of layer thickness (0.71-2.86mm) at various temperatures and air velocities on the drying of fruit leather and found the optimum depth to be 0.71 mm. Ertekin and Yaldiz (2004) investigated the effects of eggplant slice thickness (0.63, 1.27, 2.54 cm) on the drying effectiveness and reported the fastest drying times with the 0.63 cm thick slices and the most effective drying with the 2.54 cm slices.

The effect of drying temperature on the rate of drying was also investigated by several researchers. Leonard *et al.* (2005) investigated the effect of temperature (120, 140 and 160°C on the rate of drying

of municipal sludge and observed the fastest rate of drying at 160°C. Panchariya *et al.* (2002) studied thin layer drying of black tea at various temperatures (80-120°C) and air velocities and found that the highest temperature resulted in the greatest drying rate. Gely and Santalla (2007) studied the effects of initial moisture content and temperature (50-90°C) on the drying rate of quinoa seeds and observed the highest drying rates at 90°C. Brook *et al.* (2008) investigated the effects of temperature (55 and 65°C) on the drying effectiveness of tomato pieces of various geometries (whole, halves, quarters and eights) and found the fastest drying rate at 65°C for all geometries.

### 3.3. Drying Rate

The rate of moisture removal from the poultry manure at the various depths of manure and drying temperatures was calculated as follows:

$$M_R = \frac{W_i - W_f}{t_i W_d} \quad (12)$$

Where:

$M_R$  = Moisture removal rate (g moisture/g dry solid/h)

$W_d$  = Weight of dry manure at the end of the drying process (g)

$t_i$  = Drying time interval (2 h)

$W_i$  = Weight of manure at the start of a 2 h drying period (g)

$W_f$  = Weight of manure at the end of a 2 h drying period (g)

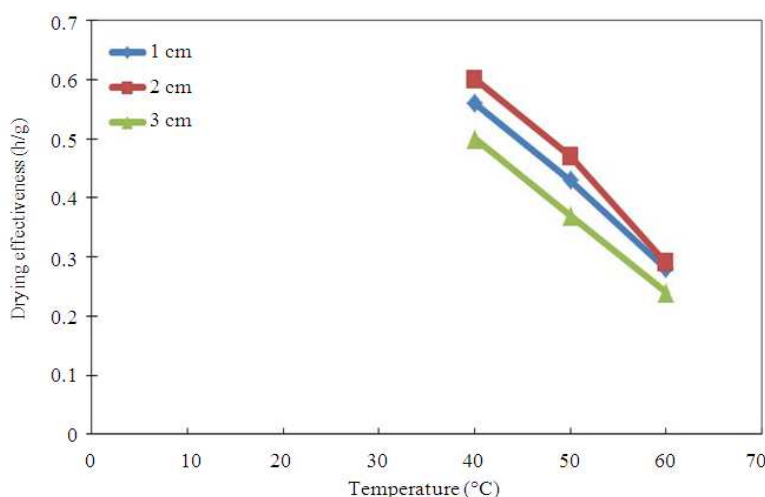

**Fig. 5.** Manure drying effectiveness

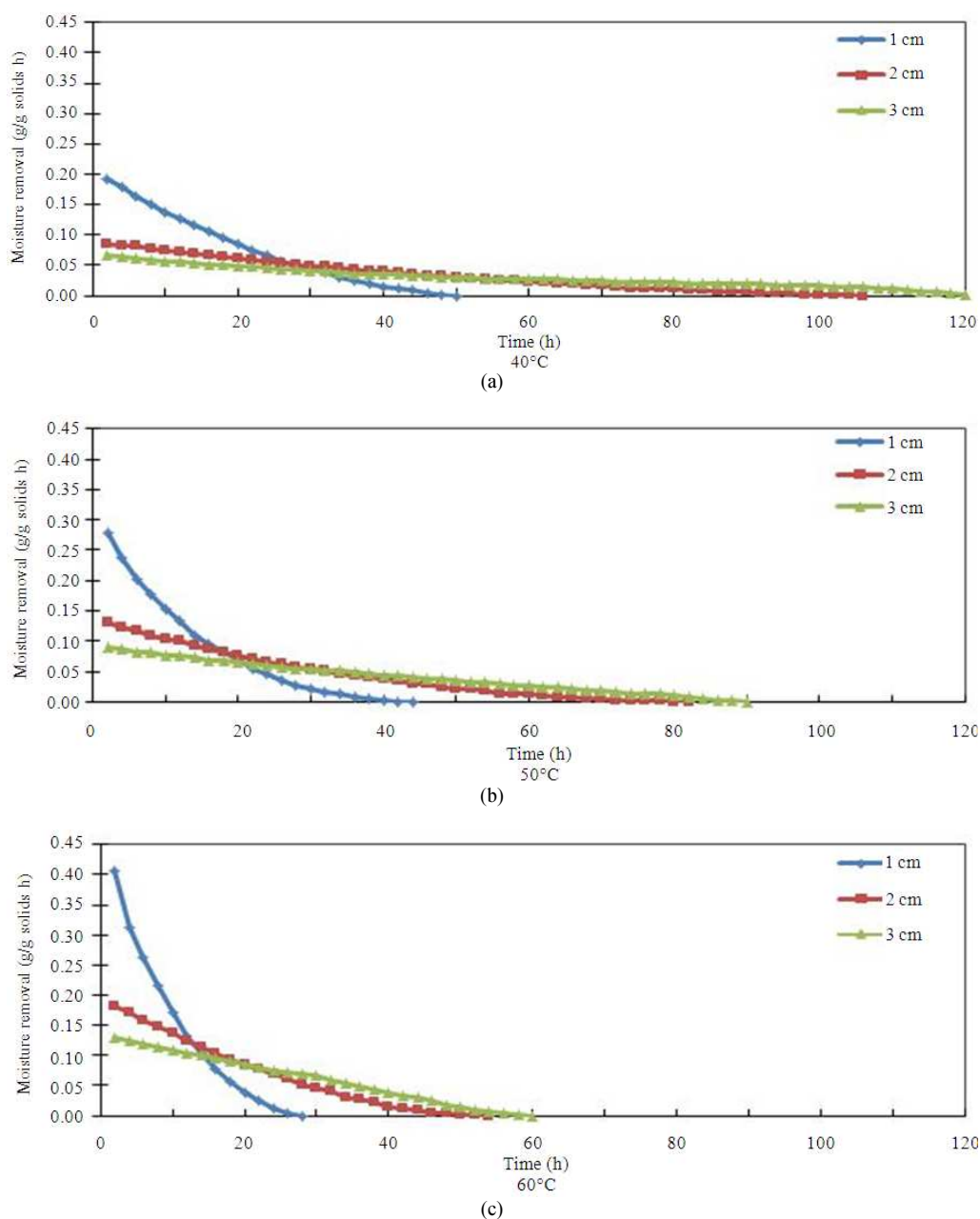

**Fig. 6.** Manure drying rate at various depths and temperatures

The plots of moisture removal rates as functions of time for the three manure depths and the three drying temperatures are shown in **Fig. 6**. The results showed that the initial drying rates were affected by both the temperature and the manure depth and the rates continued to be affected by both parameters as the drying progressed. Maskan *et al.* (2002) obtained similar results

with the drying of grape leather at various depths (0.71-2.86 mm) and temperatures (55-75°C) and observed that the thinnest samples and highest temperatures resulted in sustained higher drying rates. **Table 4** shows the regression Equation 13 to 21 that could be used to predict the rate of moisture loss as a function of time for a given temperature-manure depth combination.



**Table 4.** Equations for predicting the rate of moisture loss as a function of time

Temperature (°C)	Depth (cm)	Equation	R <sup>2</sup>	Equation
40	1	$M_R = 0.1270 - 0.004370 t + 0.000037 t^2$	1.00	13
	2	$M_R = 0.0610 - 0.000962 t + 0.000004 t^2$	1.00	14
	3	$M_R = 0.0475 - 0.000949 t + 0.000011 t^2$	0.99	15
50	1	$M_R = 0.1670 - 0.008090 t + 0.000099 t^2$	0.99	16
	2	$M_R = 0.0821 - 0.001940 t + 0.000012 t^2$	1.00	17
	3	$M_R = 0.0528 - 0.000588 t + 0.000002 t^2$	0.99	18
60	1	$M_R = 0.2530 - 0.017400 t + 0.000301 t^2$	0.99	19
	2	$M_R = 0.1240 - 0.004130 t + 0.000034 t^2$	1.00	20
	3	$M_R = 0.0838 - 0.001400 t + 0.000001 t^2$	0.99	21

\* MR = Moisture removal rate (g/g solids h); \* t = Time from the commencement of drying + 2 (h)

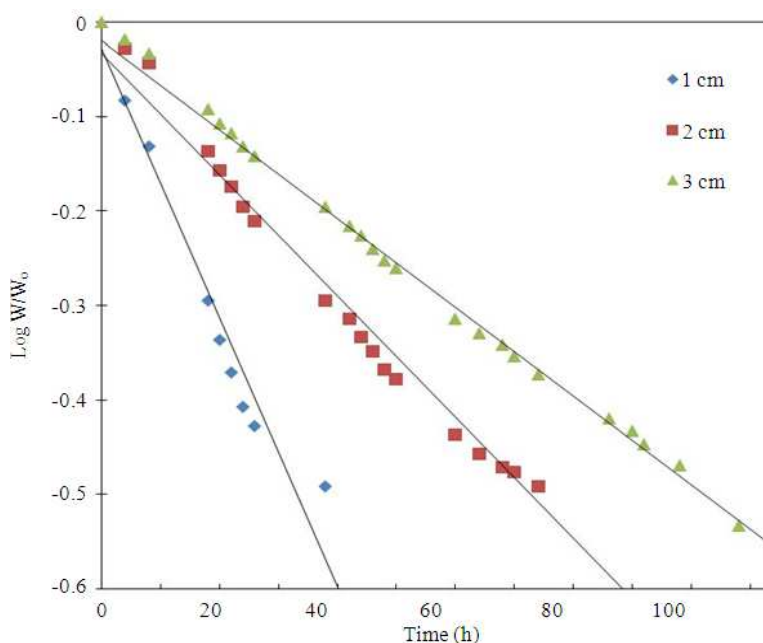

**Fig. 7.** Example of a logarithm plot of the moisture content versus time (at drying temperature of 40°C)

These equations were combined into the following regression equation that could be used to predict the moisture loss as a function of temperature, manure depth and time ( $R^2 = 0.81$ ):

$$M_R = 0.007220 + 0.032330T - 0.012307x - 0.000917t + 0.000543Tx - 0.000045Tt + 0.000623xt - 0.000029T^2 - 0.008497x^2 + 0.000006t^2 \quad (22)$$

Where:

- T = Temperature(°C)
- X = Manure layer depth (cm)

### 3.4. Apparent Diffusion Coefficient

The logarithmic model of moisture decay curves of manure drying indicated that the drying process is

controlled entirely by liquid water diffusion. The experimental results can, therefore, be interpreted using Fick's diffusion model:

$$\frac{\delta W}{\delta t} = D \frac{\delta^2 W}{dx^2} \quad (23)$$

Where:

- D = Apparent diffusion coefficient (cm<sup>2</sup>/s)
- W = Manure weight (g)

Yusheng and Poulsen (1988) showed that in cases where drying is controlled by internal mass transfer resistance, an apparent Diffusion coefficient (D) may be obtained from the slope of plot of the logarithm of the moisture content versus time. By plotting the logarithm of the ratio of the manure's weight at time t to the initial

weight of the manure at time 0 versus time (Fig. 7), the apparent diffusion coefficients were determined at all drying conditions (Table 5).

The results showed that the temperature and the manure depth had pronounced effects on the drying rate and hence on the diffusion coefficient. However the diffusivity did not vary linearly with temperature or manure depth (Fig. 8). In other words, each degree rise in temperature did not lead to an equal increase in diffusivity. With the 1 cm manure thickness, the diffusion coefficient at 40°C was about 84 and 66% of the diffusion coefficient at 50 and 60°C respectively. With the 2 cm manure thickness, the diffusion coefficient at 40°C was about 84 and 47% of diffusion coefficient at 50 and 60°C respectively. With the manure thickness of 3 cm, the diffusion coefficient at 40°C was about 72 and 43% of diffusion coefficient at 50 and 60°C respectively. It can also be shown using the diffusivity analysis that at 40°C, the diffusion coefficient of the 1 cm drying depth is about 205 % of the diffusion

coefficient of the 2 cm depth and about 285% of the diffusion coefficient of the 3 cm depth. At 50°C, the diffusion coefficient of the 1 cm thickness is about 205% of the diffusion coefficient of the 2 cm depth and about 244% of the diffusion coefficient of the 3 cm depth. At 60°C, the diffusion coefficient of the 1 cm depth is about 146% of the diffusion coefficient of the 2 cm depth and 186% of the diffusion coefficient of the 3 cm depth.

A regression Equation was therefore used to describe the variations in the diffusion coefficients with respect to temperature and manure depth as follows:

$$D = 0.003302 + 0.00327T - 0.00445 \times \tag{24}$$

The experimental and predicted diffusion coefficients (Table 5), were plotted in Fig. 9 and the results showed a very good correlation ( $R^2 = 0.95$ ). Also, the diffusion coefficients were plotted against the moisture decay constants as shown in Fig. 10 and the results showed a very good fit ( $R^2 = 0.95$ ).

**Table 5.** Apparent diffusion coefficients

Drying Depth (cm)	Drying Temperature (°C)	Experimental D (cm <sup>2</sup> /h)	Predicted D (cm <sup>2</sup> /h)
1	40	0.0130	0.0119
	50	0.0155	0.0152
	60	0.0196	0.0185
2	40	0.0064	0.0075
	50	0.0076	0.0108
	60	0.0134	0.0140
3	40	0.0046	0.0030
	50	0.0063	0.0063
	60	0.0105	0.0096

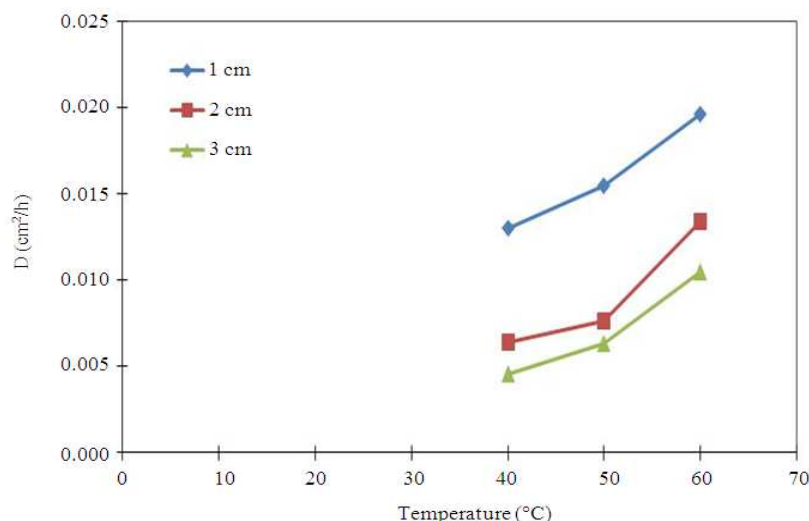

**Fig. 8.** Experimental diffusion coefficients (D)

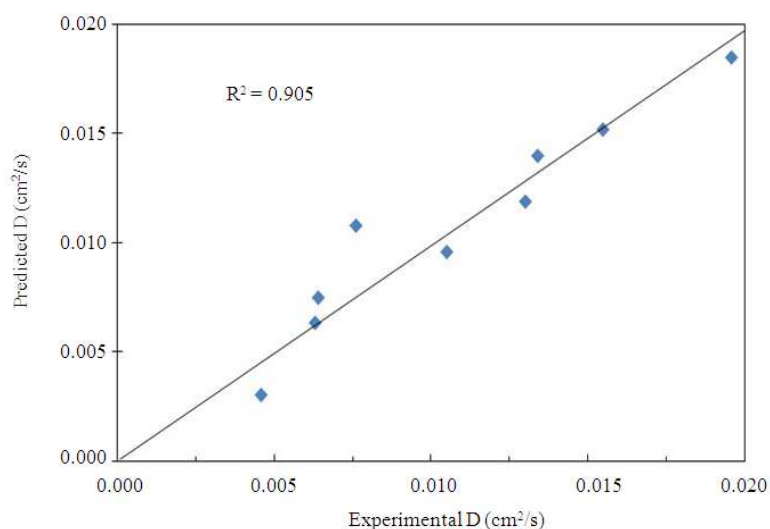

Fig. 9. Experimental and predicted apparent diffusion coefficients

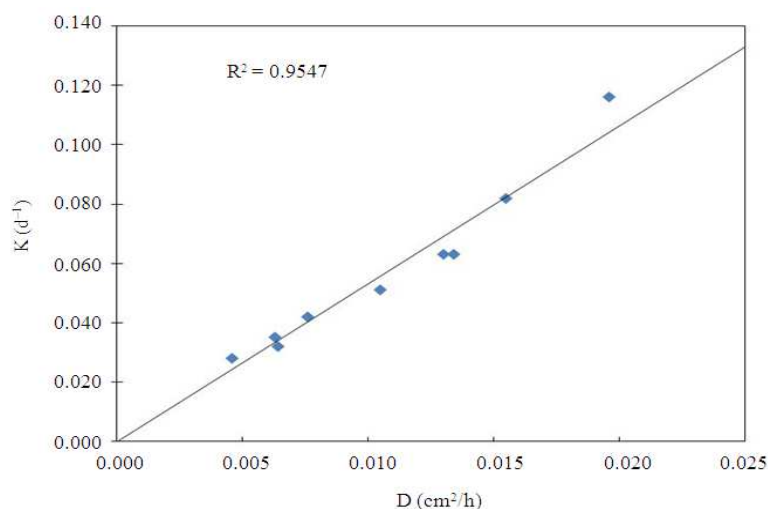

Fig. 10. Diffusion coefficients (D), vs moisture decay constants (k)

### 3.5. Microbial Count

The results of the microbial analyses are shown in **Table 6**. High numbers of bacteria ( $477 \times 10^7$  cells/g manure) and yeast and mold cells (2700 cells/g manure) were found in the raw manure. The initial number of *E. coli* in the raw manure was also high (21,986,666 cells/g manure). The drying process reduced the number of bacteria by 65.62-99.83% (from  $477 \times 10^7$ - $164 \times 10^7$  - $808 \times 10^4$  cells/g manure), the yeast and mold cells by 74.07-99.63% (from 2700 cells/g manure to 700-<10 cells/g manure) and the *E. coli* by 99.97% (from 21,986,666-6263-<10 cells/g manure). *Salmonellae* were

detected in the raw manure and the dried manure samples of the 3 cm deep layer after drying at 40°C. The results indicated that the higher the drying temperature and the thinner the manure layer, the greater the destruction of microorganisms in the dried manure.

The metabolic activities of organisms are the result of biochemical reactions, which are influenced by temperature and consequently the growth and survival of organisms are also influenced by temperature. The killing action of heat is time-temperature dependent. Practical procedures by which heat is employed are divided into two categories: (a) moist heat and (b) dry heat. However, there is a considerable difference in

the killing efficiency of moist and dry heat on organisms. Moist heat destroys microorganisms through the denaturation of the cellular proteins and the presence of moisture facilitates this process. Dry heat dehydrates the cells and destroys microorganisms through the oxidation of their intracellular constituents. Hence, dry heat (hot air) sterilization is recommended when it is either undesirable or unlikely that steam under pressure will make direct and complete contact with the material to be sterilized.

Kim *et al.* (2012) studied the thermal inactivation of broiler litter by dry heat at 70, 75 and 80°C. The time required for a 7 log reduction in *Salmonellae* was reported to be 80, 78 and 44 min for the 70, 75 and 80°C drying conditions respectively. The moisture content affected the survival of *Salmonellae* in the litter. When the initial moisture content of the broiler litter was increased from 30 to 50%, the time required to achieve a 7 log reduction was 100, 93 and 63 min for the 70, 75 and 80°C drying temperatures, respectively. Watcharasukarn *et al.* (2009) evaluated the efficiency of pathogen removal by dry heat at 37, 55 and 70°C in dairy cow manure. *E. coli* was found to be the most heat susceptible of the 3 organisms tested (*E. coli*, *E. fecali*, *C.perfringes*) and sterilization times (defines as a 10 log reduction) were found to be 5 d, 40 min and 10 s at the 37, 55 and 70°C respectively. Chang *et al.* (1974) reported that aerobic and anaerobic microbial counts were directly related to the moisture content of dehydrated cage layer

manure samples and an inverse relationship between dehydration temperature and microbial count was apparent. Aerobic and anaerobic microbial counts were significantly reduced when the moisture contents of the samples were reduced to less than 10%.

### 3.6. Manure pH

The manure pH dropped from 8.4 to about 6.9 as shown in **Table 7**. The drying temperature and drying depth did not seem to have significant effects on the pH of the dried manure.

### 3.7. Chemical Analyses

The concentrations of nitrogen, Ca, P and K in the dried poultry manure are shown in **Table 7**. Very small changes in the concentrations of Ca, P and K occurred during the drying process. However, 44-55% of the nitrogen in the manure was lost depending on the depth of the manure layer and the drying temperature, the deeper the manure layer and/or the higher the temperature the greater the nitrogen loss. On average, 51% of total Kjeldahl nitrogen (13% organic nitrogen and 38% ammonium nitrogen) in the manure was lost during the drying process. The results showed that the total protein concentration in dried manure was slightly lower than that in raw manure. Neither the drying temperature nor the depth of the manure layer appeared to have any significant effect on the final protein content of the dried manure.

**Table 6.** Average microbial count in raw and dried poultry manure

Drying temperature (°C)	Drying depth (cm)	Bacteria (10 <sup>4</sup> cells/g)	Yeast/Mold (cells/g)	<i>E. Coli</i> (10 <sup>4</sup> cells/g)	<i>Salmonellae</i> (preserve)
40	1	55000	250	10	ND <sup>a</sup>
	2	69000	370	20	ND <sup>a</sup>
	3	75000	430	30	PP <sup>b</sup>
50	1	2100	170	<10	ND <sup>a</sup>
	2	2900	210	10	ND <sup>a</sup>
	3	4100	310	20	ND <sup>a</sup>
60	1	440	<10	<10	ND <sup>a</sup>
	2	530	<10	<10	ND <sup>a</sup>
	3	620	<10	<10	ND <sup>a</sup>
Raw manure		477000	2700	2290	PP <sup>b</sup>

a- Not Detected; b- Partially Detected

**Table 7.** Essential elements in raw and dried poultry manure.

Drying temperature (°C)	Drying depth (cm)	pH	Calcium (%)	Phosphorous (%)	Potassium (%)	Nitrogen (mg/kg)			Protein (mg/kg)
						TKN	Org-N	NH <sub>4</sub> -N	
40	1	6.6	9.15	2.46	1.91	49350	36370	12980	40.66
	2	6.4	9.16	2.45	1.90	46290	33450	12840	42.24
	3	6.6	9.16	2.46	1.91	43810	32960	10850	42.39
50	1	6.7	9.15	2.45	1.90	45810	33920	11890	39.76
	2	6.7	9.14	2.45	1.89	43490	32610	10880	41.96
	3	6.7	9.14	2.46	1.90	41880	32060	9820	42.02
60	1	6.6	9.14	2.45	1.89	41180	32930	8250	39.48
	2	6.5	9.13	2.44	1.90	39890	31600	8290	41.49
	3	6.6	9.13	2.45	1.89	39260	30940	8320	41.59
Raw manure		8.4	9.17	2.48	1.92	87970	43940	17540	43.32

**Table 8.** Odor rating

Parameter	Dried	Raw
Presence	3.47±1.25	10
Offensiveness	3.07±1.53	10
Description		
Grain, Feed	10	-
Mold, Musty	6	-
Sour, Fermented	4	-
Yeast	2	-
Earth	2	-
Fish	2	-
Sulfide, Rotten Egg	2	12
Ammonia	2	2
Stagnant water	-	13
Rotten Cabbage Mercaptans	-	3

a- Total number of observations- 30

### 3.8. Odor

At the start of each experiment, the odor given off near the oven during the drying process was noticeable. However, as the drying process progressed, the presence and offensiveness of the odor decreased with time and the final product (dried manure) did not have any offensive odor. The results of the organoleptic test (**Table 8**) showed that both the presence and offensiveness of the odor in the dried poultry manure were reduced by 65.3 and 69.3% (when compared to that of the fresh poultry manure), respectively. The odor present in the dried manure was not offensive (23.3% of the panel members described the odor as that of grain, 20% described it as a mold musty, 13.3% described it as ammonia, 13.3% described it as sour/fermented, 6.7% described it as fish odor, 6.7% described it as yeast odor and 6.7% described it as sulfide rotten eggs odor).

### 4. CONCLUSION

The profile of the moisture content of poultry manure followed an exponential decay curve. The moisture decay constant was affected by the drying temperature and the depth of the manure layer. At the three temperature levels studied, the time required to dry poultry manure in the 1 cm-deep layer was the least, followed by the 2 and 3 cm-deep layers, respectively. The diffusion coefficients increased with both temperature and depth of drying layers, but did not show linear increases with either variable. The optimum depth to dry manure (at which the highest drying effectiveness occurred) was 3 cm. Drying manure at 40-60°C resulted in the loss of 44-55% of the total Kjeldahl nitrogen, with

losses increasing with both the temperature and depth of manure. The pH of the manure decreased from the initial value of 8.4 before drying to about 6.6 after drying. The odor analysis indicated that dried poultry manure did not have an offensive odor. Drying achieved 65.3 and 69.3% reductions in odor intensity and offensiveness, respectively. A significant reduction in the microbial population was achieved at all drying conditions. The greatest reductions in the microbial population occurred at the highest temperature (60°C) and the lowest manure depth (1cm). Reductions in the number of bacteria, mold/yeast and *E.coli* were 65-99, 74-99 and 99.97% respectively. Heated air drying of poultry manure at temperatures between 40 and 60°C proved effective in killing pathogens and removing odor.

### 5. ACKNOWLEDGEMENT

This research was funded by the Natural Science and Engineering Research Council (NSERC) of Canada.

### 6. REFERENCES

- Alam, M.S., M.J. Khan, M.A. Akbar and M. Kamruzzaman, 2008. Broiler litter and layer manure in the diet of growing bull calves. *Bangladesh Veterinarian*, 25: 62-67. DOI: 10.3329/bvet.v25i2.4619
- Amine-Khodja, A., C. Richard, B. Lavedrine, G. Guyot and O. Trubetskaya *et al.*, 2006. Water-soluble fractions of composts for the photodegradation of organic pollutants in solar light. *Environ. Chem. Lett.*, 3: 173-177. DOI: 10.1007/s10311-005-0028-8
- Amon, B., V. Kryvoruchko, T. Amon and S. Zechmeister-Boltenstern, 2006. Methane, nitrous oxide and ammonia emissions during storage and after application of dairy cattle slurry and influence of slurry treatment. *Agric. Ecosyst. Environ.*, 112: 153-162. DOI: 10.1016/j.agee.2005.08.030
- AOAC, 2006. Official Methods of Analysis of AOAC International. 18th Edn., AOAC International, Gaithersburg, MD., ISBN-10: 0935584773, pp: 2400.
- APHA, 1981. Standard Methods for the Examination of Water and Wastewater. 15th Edn., American Public Health Association, Washington, DC., ISBN-10: 0875530915, pp: 1134.
- ASABE, 2008. ASABE Standards. 55th Edn., American Society of Agricultural and Biological Engineers, Saint Joseph, MI., ISBN-10: 1892769670, pp: 1168.

- Axtell, R.C., 1999. Poultry integrated pest management: status and future. *Integrated Pest Manage. Rev.*, 4: 53-73. DOI: 10.1023/A:1009637116897
- Benali, M. and T. Kudra, 2002. Thermal dewatering of diluted organic suspensions: Process mechanism and drying kinetics. *Dry. Technol.*, 20: 935-951. DOI: 10.1081/DRT-120003770
- Bon, J., S. Simal, C. Rosselló and A. Mulet, 1997. Drying characteristics of hemispherical solids. *J. Food Eng.*, 34: 109-122. DOI: 10.1016/S0260-8774(97)00098-8
- Brooks, M.S., N.H. Abou El-Hana and A.E. Ghaly, 2008. Effects of tomato geometries and air temperature on the drying behavior of plum tomato. *Am. J. Applied Sci.*, 5: 1369-1375. DOI: 10.3844/ajassp.2008.1369.1375
- Chang, T.S., D. Dorn and H.C. Zindel, 1974. Stability of poultry anaphage. *Poult. Sci.*, 5: 2221-2224. DOI: 10.3382/ps.053221
- DeBoer, A.J., 1981. Socioeconomic aspects of dairying in developing countries. *J. Dairy Sci.*, 64: 2453-2462. DOI: 10.3168/jds.S0022-0302(81)82870-6
- El-Sayed, H.S., 1993. Solar drying of poultry manure for animal feed under simulated Egyptian conditions. Unpublished PhD thesis, Cairo University, Giza, Egypt.
- Ertekin, C. and O. Yaldiz, 2004. Drying of eggplant and selection of a suitable thin layer drying model. *J. Food Eng.*, 63: 349-359. DOI: 10.1016/j.jfoodeng.2003.08.007
- FAO, 2010. *Agricultural Handbook: Poultry Meat and Eggs*. 1st Edn., FAO Investment Center Division, Rome Italy.
- Fares, F., A. Albalkhi, J. Dec, M.A. Bruns and J.M. Bollag, 2005. Physicochemical characteristics of animal and municipal wastes decomposed in arid soils. *J. Environ. Q.*, 34: 1392-1403. DOI: 10.2134/jeq2004.0257
- Gely, M.C. and E.M. Santalla, 2007. Moisture diffusivity in quinoa (*Chenopodium quinoa* Willd.) seeds: Effect of air temperature and initial moisture content of seeds. *J. Food Eng.*, 78: 1029-1033. DOI: 10.1016/j.jfoodeng.2005.12.015
- Hawtlader, M.N.A., M.S. Uddin, J.C. Ho and A.B.W. Teng, 1991. Drying characteristics of tomatoes. *J. Food Eng.*, 14: 259-268. DOI: 10.1016/0260-8774(91)90017-M
- Kelleher, B.P., J.J. Leahy, A.M. Henihan, T.F. O'Dwyer and D. Sutton *et al.*, 2002. Advances in poultry litter disposal technology- a review. *Bioresource Technol.*, 83: 27-36. DOI: 10.1016/S0960-8524(01)00133-X
- Kim, J., J. Dia, M.W. Shepherd, R. Singh, S.D. Heringa and C. Gong *et al.*, 2012. Validating thermal inactivation of *Salmonella* spp. in fresh and aged chicken litter. *Applied Environ. Microbiol.*, 78: 1302-1307.
- Krokida, M.K., V.T. Karathanos, Z.B. Maroulis and D. Marinos-Kouris, 2003. Drying kinetics of some vegetables. *J. Food Eng.*, 59: 391-403. DOI: 10.1016/S0260-8774(02)00498-3
- Lay, Jr. D.C., R.M. Fulton, P.Y. Hester, D.M. Karcher and J.B. Kjaer *et al.*, 2011. Hen welfare in different housing systems. *Poult. Sci.*, 90: 278-294. DOI: 10.3382/ps.2010-00962
- Leonard, A., S. Blacher, P. Marchot, J.P. Pirard and M. Crine, 2005. Convective drying of wastewater sludges: Influence of air temperature, superficial velocity and humidity on the kinetics. *Dry. Technol.: Int. J.*, 23: 1667-1679. DOI: 10.1081/DRT-200065082
- Loehr, R.C., 1977. *Food, Fertilizer and Agricultural Residues*. 1st Edn., Ann Arbor Science Publishers Inc, Michigan, Illinois, ISBN-10: 0250401908, pp: 727.
- Maskan, A., S. Kaya and M. Maskan, 2002. Hot air and sun drying of grape leather (pestil). *J. Food Eng.*, 54: 81-88. DOI: 10.1016/S0260-8774(01)00188-1
- Miller, D.N. and E.D. Berry, 2005. Cattle feedlot soil moisture and manure content. *J. Environ. Q.*, 34: 644-655. DOI: 10.2134/jeq2005.0644
- Nazghelichi, T., M.H. Kianmehr and M. Aghbashlo, 2010. Thermodynamic analysis of fluidized bed drying of carrot cubes. *Energy*, 35: 4679-4684. DOI: 10.1016/j.energy.2010.09.036
- Okos, M.R., G. Narismhan, R.K. Singh and A.C. Witnauer, 1992. Food Dehydration. In: *Handbook of Food Engineering*, Heldman, D.R. and D.B. Lund, (Eds.), CRC Press, Boca Raton, ISBN-10: 0824753313, pp: 1023.
- Panchariya, P.C., D. Popovic and A.L. Sharma, 2002. Thin-layer modelling of black tea drying process. *J. Food Eng.*, 52: 349-357. DOI: 10.1016/S0260-8774(01)00126-1

- Pierson, S.T., M.L. Cabrera, G.K. Evanylo, H.A. Kuykendall and C.S. Hoveland *et al.*, 2001. Phosphorus and ammonium concentrations in surface runoff from grasslands fertilized with broiler litter. *J. Environ. Q.*, 30: 1784-1789. DOI: 10.2134/jeq2001.3051784x
- Rao, P.S., S. Bal and T.K. Goswami, 2007. Modelling and optimization of drying variables in thin layer drying of parboiled paddy. *J. Food Eng.*, 78: 480-487. DOI: 10.1016/j.jfoodeng.2005.10.019
- Srinivasa, S., 2007. Capacity limits of cognitive radio with distributed and dynamic spectral activity. *IEEE J. Selected Areas Commun.*, 25: 529-537. DOI: 10.1109/JSAC.2007.070403
- Tam, N.F.Y. and S.M. Tiquia, 1999. Nitrogen transformation during co-composting of spent pig manure, sawdust litter and sludge under forced-aerated system. *Environ. Technol.*, 20: 259-267. DOI: 10.1080/09593332008616816
- Tanabe, Y., K. Tanaka and Z. Kato, 1985. Feeding poultry waste to chickens, swine and cattle. *Proceedings of the Agricultural Waste Utilization and Management, (AWUM' 85)*, ASAE Publication, St. Joseph, Michigan, pp: 13-85.
- Thomas, J.W., Y. Yu, P. Tinnimitt and H.C. Zindel, 1972. Dehydrated poultry waste as a feed for milking cows and growing sheep. *J. Dairy Sci.*, 55: 1261-1265. DOI: 10.3168/jds.S0022-0302(72)85659-5
- Watcharasukarn, M., P. Kaparaju, J.P. Steyer, K.A. Krogfelt and I. Angelidaki, 2009. Screening *Escherichia coli*, *Enterococcus faecalis*, and *Clostridium perfringens* as indicator organisms in evaluating pathogen-reducing capacity in biogas plants. *Microbial. Ecol.*, 58: 221-230. DOI: 10.1007/s00248-009-9497-9
- Yusheng, Z. and K.P. Poulsen, 1988. Diffusion in potato drying. *J. Food Eng.*, 7: 249-262. DOI: 10.1016/0260-8774(88)90007-6
- Zhang, W. and A. Lau, 2007. Reducing ammonia emission from poultry manure composting via struvite formation. *J. Chem. Technol. Biotechnol.*, 82: 598-602. DOI: 10.1002/jctb.1701